

! INFO !

Do not charge the battery of the towing vehicle and/or towed vehicle directly via the socket.

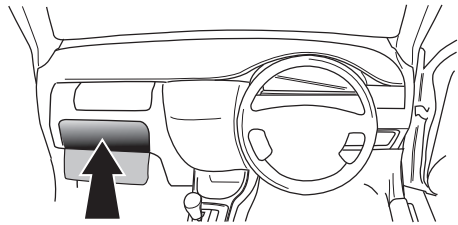

User guide

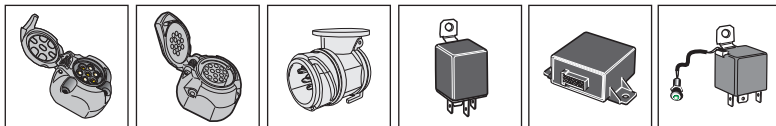

SPARE PARTS

www.ecs-electronicsuk.co.uk



Partnr.: AU-056-D1U

User Guide

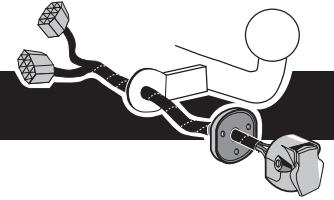

Only for models without towbar preparation

**Audi A6 Sedan 2011- (4G)
Audi A7 Sportback 2010- (4G)
Audi A6 Avant 2012- (4G5)**

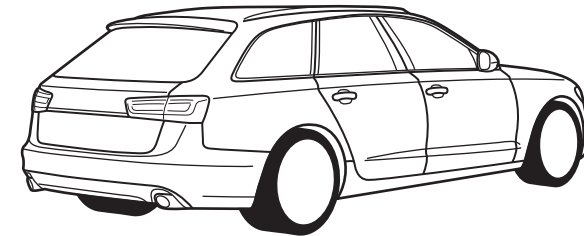
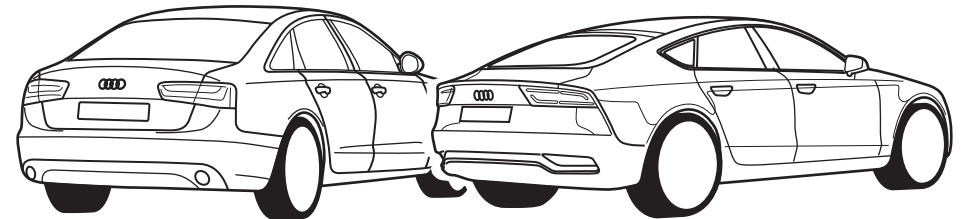

INFO

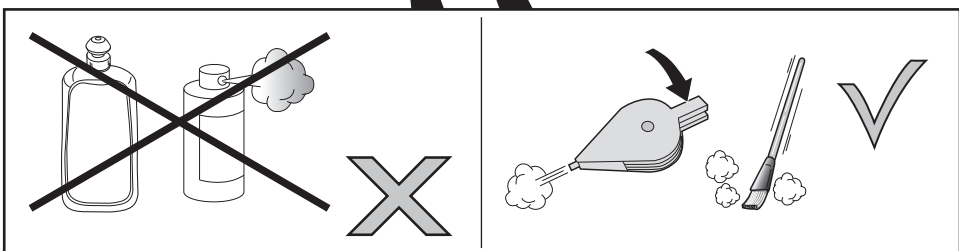
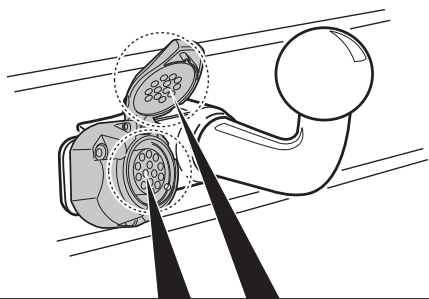
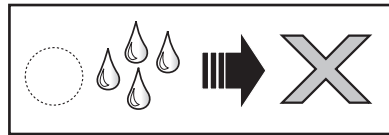
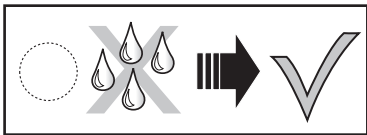
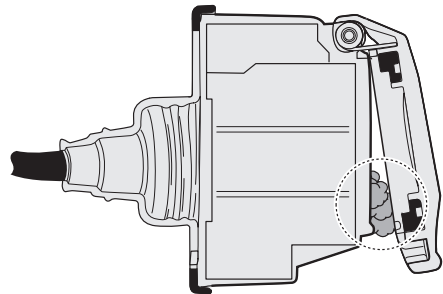
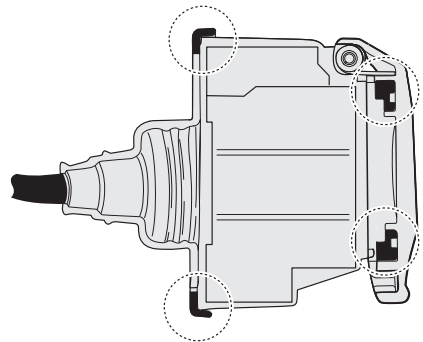
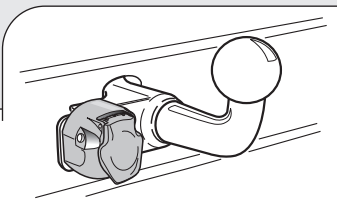
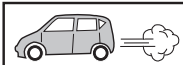

CHANGING THE FUSE

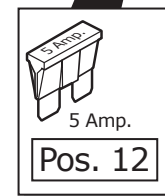
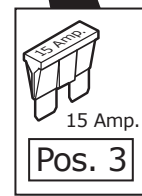
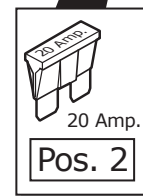
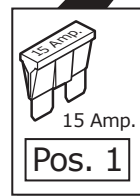
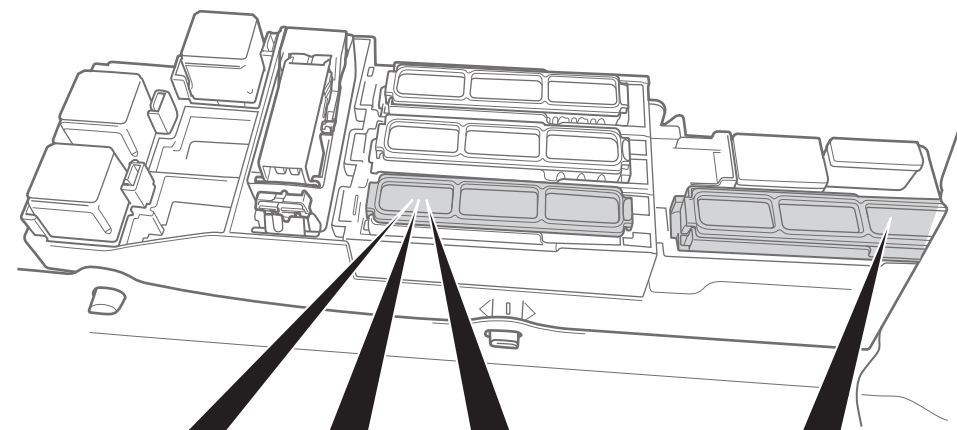
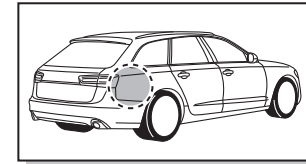
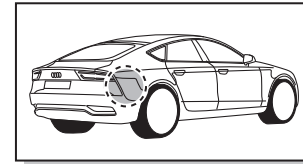
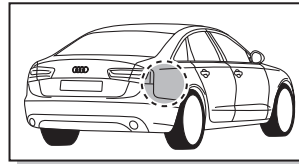

SOCKET CONNECTION

DIN/ISO 11446			1-8					Reverse				10	11	12	13
	1/L	2	3/31	4/R	5/58-R	6/54	7/58-L	8	9	10	11	12	13		
Pmax	21W	21W		21W	42W	3x21W	42W	21W	180W/15Amp	180W/15Amp					
Colour	Black/White	Blue	Brown	Black/Green	Grey/Red	Black/Red	Grey/Black	Black	Red	Yellow	Brown	-	Brown		

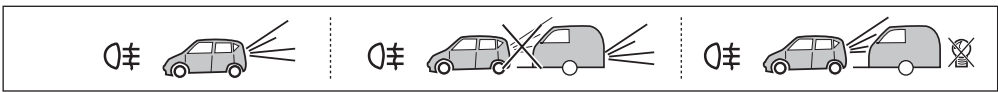

In a coupled trailer with working fog lamp, the fog lamp of the vehicle will be switched off, if applicable.

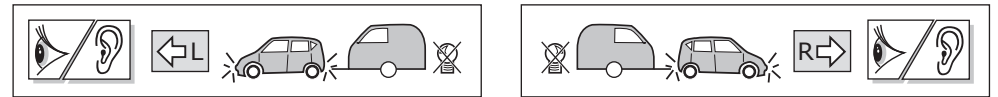

The flashing lights on the trailer are monitored. If one of the indicators of the trailer breaks down, a buzzer will be audible and/or a visual signal will be visible on the dashboard. Check the flashing lights on the trailer.

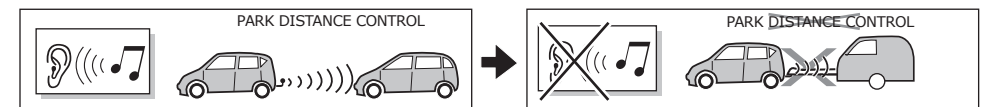

The wiring kit has a possibility to switch off any Park Distance Control in the case of a coupled trailer.

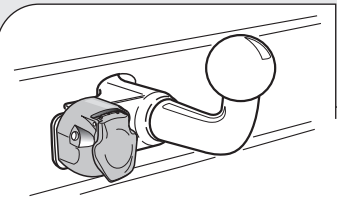

INFO : Ring.

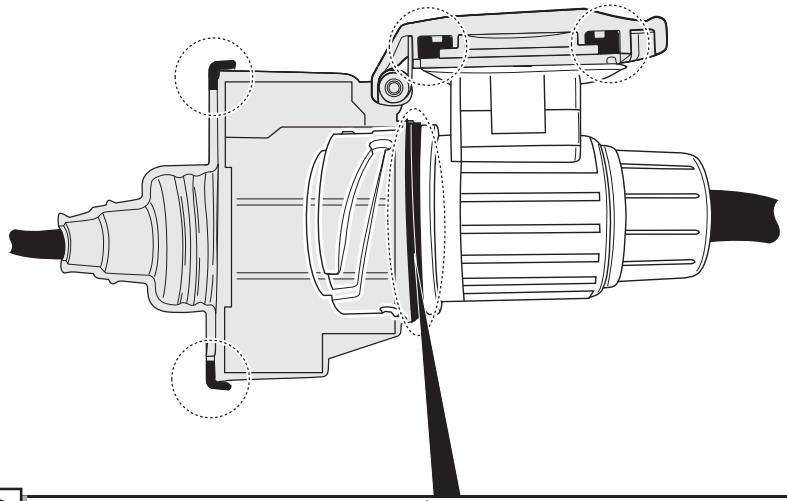
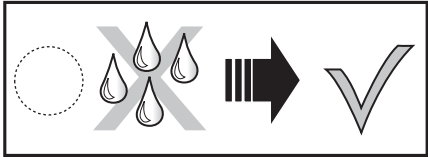

INFO

INFO : Adapt.

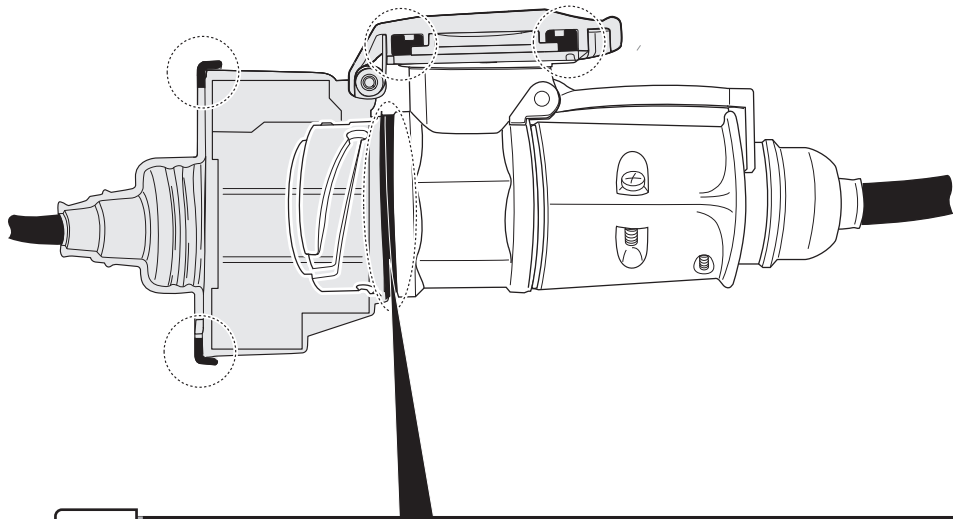
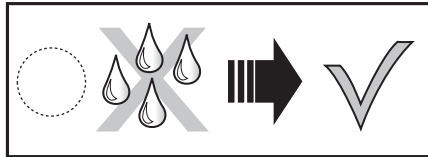
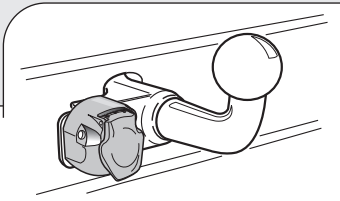
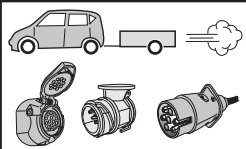

INFO

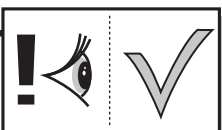
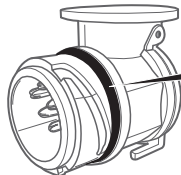
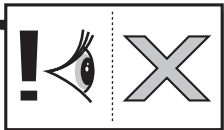
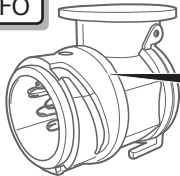

INFO : Storage

